

Slim

idea: *Pietro Lovato*



Engineering
Polymer Shell is
**100%
recyclable**

Caratterizzata da un design semplice, SLIM è una sedia che si adatta a diversi ambienti: dall'ufficio alla cucina, alla cameretta. Ciò che la differenzia dalle altre è l'innovativo materiale di cui è fatta: il polimero tecnico rende SLIM flessibile in modo intelligente e la sedia asseconda tutti i movimenti del corpo garantendo una posizione ergonomica. Inoltre il polimero tecnico è un materiale riciclabile al 100%. Disponibile anche in versione ignifuga bianca.

Characterized by a simple design, SLIM fits well in different spaces: from the office, to the kitchen, to the bedroom.

The innovative material of which it is made is the main peculiarity that diversifies SLIM from the others chairs: the engineering polymer makes SLIM flexible in an intelligent way, by supporting all body movements in order to guarantee an ergonomic position. Furthermore this engineering polymer is a 100% recyclable material. Also available in fireproof white version.

Caractérisée par un design simple, SLIM est une chaise qui s'adapte à plusieurs ambiances : du bureau à l'accueil, de la salle de réunion à la salle à manger. Ce qui fait la différence entre cette chaise et les autres est le matériel innovant dont elle est composée: le polymère technique rend la SLIM flexible de façon intelligente ; en effet la coque suit les mouvements du corps en permettant une position ergonomique. Encore, le polymère technique est un matériel 100% recyclable. Disponible même en version non feu, blanche.

Mit seinem schlichten Design, eignet sich die SLIM Stuhlfamilie an verschiedene Einrichtungen wie Büros, Küchen und Schlafzimmer. Das innovative verwendete Material unterscheidet diese Stuhlfamilien von anderen Wettbewerber. Durch den technischen Polymer Kunststoff wird die Schale flexibel und gewährleistet eine ergonomische Haltung. Ausserdem ist dieser innovativen Kunststoff 100% recycelbar. Die SLIM Schale ist in verschiedenen Farben erhältlich und kann vollgepolstert oder nur mit Sitzkissen versehen sein. In der feuerfeste Version in weiß erhältlich.

Caracterizada por un diseño simple, SLIM es una silla que se adapta a diferentes entornos: de la oficina a la cocina y el dormitorio. Lo que diferencia a esta silla de las otras es el material innovador del que está hecha: el polímero técnico hace que SLIM sea flexible de manera inteligente y la silla acompaña todos los movimientos del cuerpo y garantiza una posición ergonómica. Además, el polímero técnico es un material 100% reciclable. También disponible en versión ignífuga blanca.

Slim



SLIM COLLECTION

SlimTask

Girevole, scocca in tecnopolimero, struttura in metallo. Con braccioli, tappezzata a fasce e tappezzata a fasce con braccioli.

Swivel, engineering polymer shell, metal structure. With armrest, stripe uphol. shell, stripe uphol. shell with armrest.

Pivotant, coque en polymère technique, structure en métal. Avec acc., tapissée en bandes, tapissée en bandes avec acc.

Drehbar, Technopolymer Schale, Metallgestell mit oder ohne Arm. Gepolst. mit Stepp. mit oder ohne Arm.

Giratoria, carcasa de termopolímero, estructura metálica. Con brazos, tapizada en bandas y tapizada en bandas con brazos.



versions
Task
Task Stool

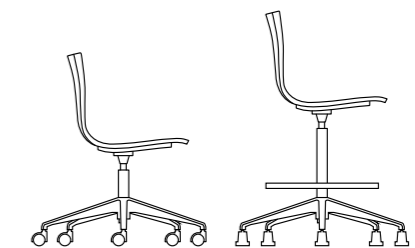

SlimTask



Slim /Task+armrest
SL0073



Slim /Task
SL0323



Slim /Task+armrest
SL0073+XA014



Slim /Task
SL0323+XA014

SlimTask

SLIM COLLECTION

SlimTask



Slim /Task
SL0323+XS002





Slim /Stool
SL0052+XP001

SLIM COLLECTION

SlimTask

Stool



Slim /Stool
SL0050+XP001+XC017



Slim /Stool
SL0052+XP001

SlimTask

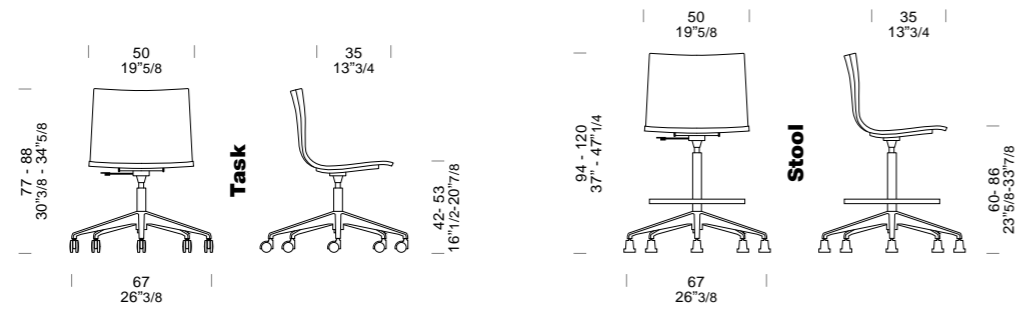

STRUTTURA:

Monoscocca in tecnopolimero, finitura RAL o imbottita con spugna e rivestita in tessuto, con struttura di sostegno in tubo tondo d'acciaio, Ø16mm, con o senza braccioli, finitura cromata (15µm) o verniciata a polveri.

STRUCTURE:

Engineering polimer mono-coque, ral finish or foam padded and upholstered. Round steel bar structure Ø16mm, with or without armrests, chromed finish (15µm) or powder coated.

STRUCTURE:

Monocoque en polymère technique, finition RAL ou rembourrée de mousse et tapissée. Structure de support en tube d'acier, Ø16mm, avec ou sans accoudoirs, finition chromé (15µm) o verni époxy.

STRUKTUR:

Technopolymer Schale, RAL Farben oder mit gepolsterten Schaumstoff, Rund-Stahlrohrrahmen Ø 16mm, mit oder ohne Armlehnen, verchromt (15µm) oder pulverbeschichtet.

ESTRUCTURA:

Monocasco de termopolimero, acabado RAL o acolchado con espuma y recubierto en tejido, con estructura de soporte en tubo de acero redondo, Ø16mm, con o sin brazos, acabado cromado (15µm) o con recubrimiento en polvo.

SlimTask



5-spoke
polished aluminium



5-spoke
black polyamide base



Ø 50 mm
self-braking,
black finish



Ø 50 mm
soft self-braking,
black finish



h 61 mm
black finish

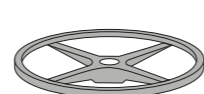

XP001
footrest ring
(high gas lift only)



metal armrest
XB030 - chromed
XB026 - white
XB035 - black

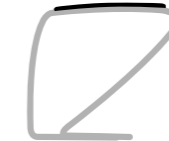

metal armrest with upholstered pad
XB040 - chromed
XB039 - white
XB042 - black

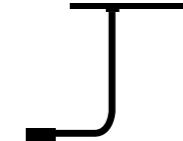

XS002
writing tablet

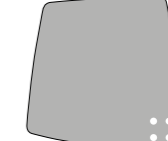

XS003
writing tablet
22x28 cm



XC017
cushion

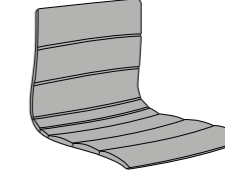

XA014
padded upholstery

Per approfondimenti su meccanismi, braccioli e certificazioni consultare la sezione tecnica a pag. 24. / For further information on mechanisms, armrests and certifications, consult the technical section on page 24. / Pour plus d'informations sur les mécanismes, les accoudoirs et les certifications, consultez la section technique p. 24. / Weitere Informationen zu Mechanismen, Armlehnen und Zertifizierungen finden Sie im technischen Abschnitt auf Seite 24. / Para más información sobre mecanismos, brazos y certificaciones, consulte el apartado técnico en p. 24.



ID 1111209613

